

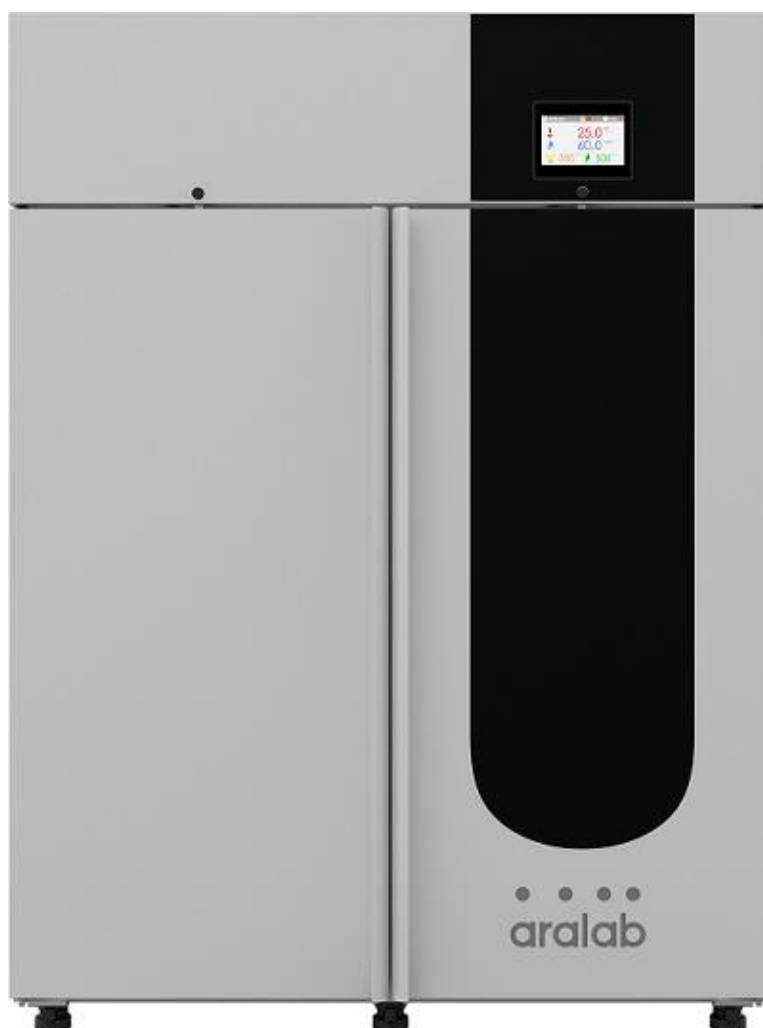

BIO

FITOCLIMA 600 & 1200 BIO

PLANT GROWTH RESEARCH 'REACH-IN' ENVIRONMENTAL CHAMBERS

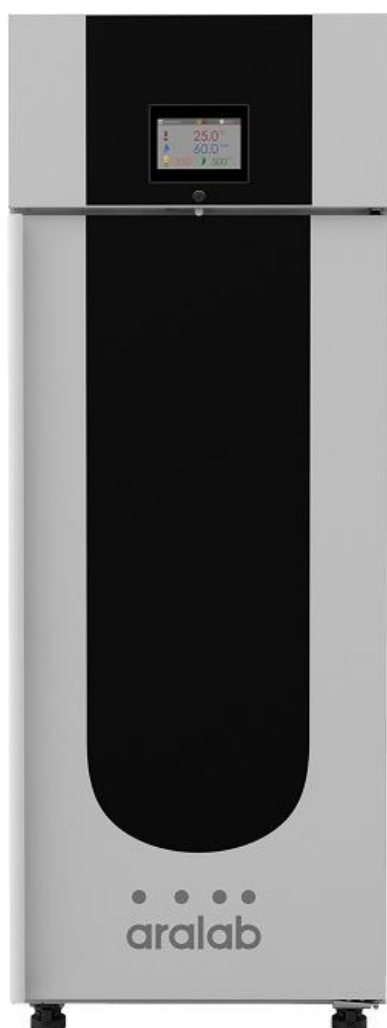



Common applications include:

- Plant Growth
- Tissue Culture
- Arabidopsis
- Germination
- Algae Research
- Entomology
- Insect storage
- Other life sciences applications

FitoClima Bio chambers provide the control and flexibility to meet the evolving needs of researchers and research requirements through time.



ARALAB

ARALAB is a company specialized in designing, developing, manufacturing and servicing of high quality environmental chambers and controlled environment rooms.

Since 1985 we have been perfecting ways to create and control temperature, humidity, light, air flow and many other environmental conditions.

Only the highest quality components are used to manufacture our chambers so customers can have the best equipment for their research and testing purposes.

Aralab. Your own climate.



Certified ISO:9001 for its Quality Management System

KEY FEATURES

- Ready to use. No assembly needed
- Minimal footprint for efficient use of laboratory space
- Adaptive future proof design, with easily removable and height adjustable shelves and changeable light canopies with multiple intensities
- Wide temperature and humidity working ranges
- Research protection, with configurable high / low temperature and humidity alarms and automatic remote notifications
- Stainless steel interior for maximum durability and easiness of cleaning
- Multiple lighting options to suite any research requirements and stages of plant development

TECHNICAL SPECIFICATIONS

TECHNICAL DATA FOR FITOCLIMA 600 & 1200 BIO CHAMBERS

	TEMPERATURE RANGE ^[1]	LIGHTS ON LIGHTS OFF	+5°C to +45°C -5°C to +45°C
	TEMPERATURE PRECISION		± 0,5°C
	TEMPERATURE UNIFORMITY		± 1,0°C
	HUMIDITY RANGE ^[1]	LIGHTS ON LIGHTS OFF	40 to 80% RH 40 to 95% RH
	HUMIDITY PRECISION		± 1% RH
	HUMIDITY UNIFORMITY		± 2% RH
	SHELVES / LIGHT BANKS ^[2]		FitoClima 600: 1 to 4 shelves with controlled lighting FitoClima 1.200: 2 to 8 shelves with controlled lighting
	GROWTH HEIGHT		Adjustable from 150mm up to 1.330 mm
	GROWTH AREA		0.33m ² per shelf (0.64cm x 0.52cm)
	LIGHT TYPES AND INTENSITIES ^[2a]		Maximum number of light shelves by light type:
	Approximate intensity per shelf (±10%)	Light Type	FitoClima 600 FitoClima 1.200
	200 or 250 µmoles/m ² s	4 cool-white fluorescent or white LED tubes	4 8
	400 or 500 µmoles/m ² s	8 cool-white fluorescent or white LED tubes	2 or 3 4 or
	Up to 600 µmoles/m ² s	Multiple spectra LED options	2 or 3 4
	1.000 µmoles /m ² s ^[2.b]	High performance fluorescent or LED	1 2
	Up to 300 µmoles/m ² s	Vertical LEDs installed on the side walls	N/A N/A
	AIRFLOW		Uniform 0,2 m/s across the shelves. Adjustable by setpoint % at the controller interface
	INTERNAL VOLUMES		600 or 1.200 liters

INSTALLATION REQUIREMENTS

	WATER (FOR MODELS WITH HUMIDITY CONTROL)	Demineralized or R.O water. 1 to 5 bar pressure and ≤ 10u siemens conductivity
	INSTALLATION PLACE AND DRAIN	Clean and airy place, with a room temperature between 10°C and 26°C. Drain at floor level and near the equipment
	WEIGHT OF EQUIPMENT	FitoClima 600: 175 Kg FitoClima 1.200: 250 Kg
	ELECTRICAL CONNECTION	1PH AC 230V ±10% 50Hz 5 to 12A (depending on model)

FITOCLIMA MODELS REFERENCE – STANDARD CONTROLLED ENVIRONMENT VARIABLES

FITOCLIMA 600/1200 P		Temperature only
FITOCLIMA 600/1200 PL		Temperature and Light
FITOCLIMA 600/1200 PH		Temperature and Humidity
FITOCLIMA 600/1200 PLH		Temperature, Light and Humidity
FITOCLIMA 600 PDH		Temperature and Low Humidity (ambient down to 5% RH)

[1] Temperature and humidity ranges with all lights ON (5°C and 80%RH) are affected by chosen light configuration and configured light intensity. Due to heat dissipation from the lamps, high light intensities will affect high humidity and low temperature ranges

[2] Standard included light configuration: 4x18W fluorescent on each shelf. 3 light shelves on the FitoClima 600 and 6 on the FitoClima 1.200. FitoClima 600 with Vertical LED Lights option has 5 wire shelves (1,65m²) included as standard, and up to 10 can be fitted optionally.

[2a] Measurements at 150mm from lamps at 25°C. At lower temperatures light intensities will decrease, except with LED lighting options

[2b] Intensity available with "High Performance lighting (1.000 µmole/m²s) kit" as an option

DIMENSIONS AND DRAWINGS

FITOCLIMA 600

	EXTERNAL DIMENSIONS (HxWxD) (mm)	1.980 x 745 x 950
	INTERNAL DIMENSIONS (HxWxD) (mm)	1.330 x 600 x 680

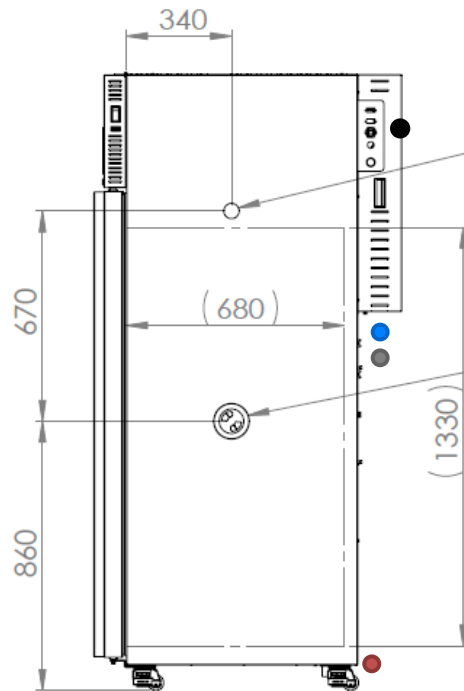
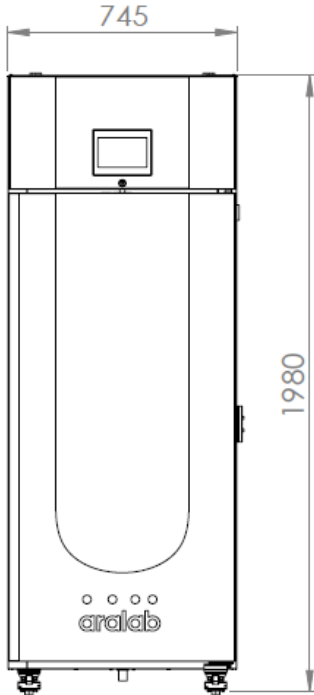

Fresh air intake
(Ø21 mm)

Exhaust air and passthrough
(Ø80 mm)

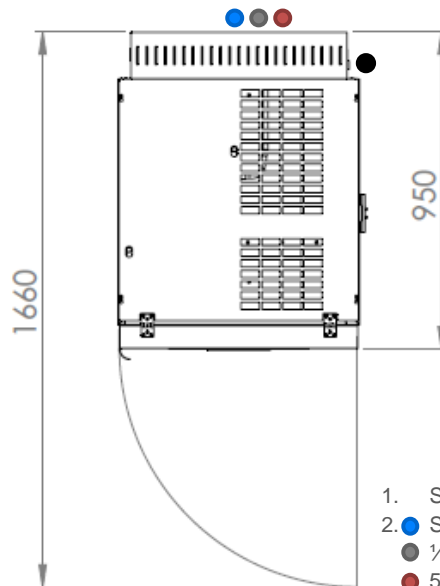
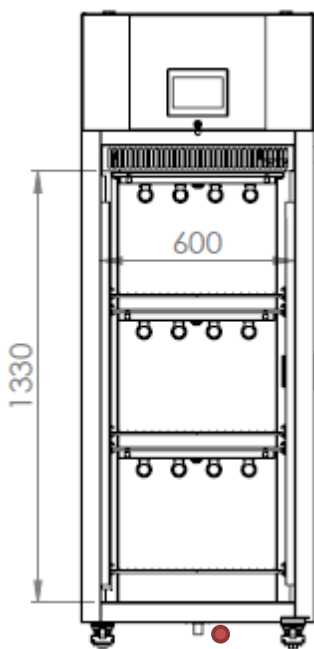

- Standard refrigeration system is air cooled
- Services hub installation needs:
 - 1/2" demineralized water supply
 - 50mm water drain at floor level
- Electrical cabinet installation needs:
 - Supply power: 230VAC, 50Hz, 16A / Single Phase + Neutral + Ground
 - Electrical protection: Circuit breaker 16A + N with 300mA differential
 - RJ45 communication port

FITOCLIMA 1.200

	EXTERNAL DIMENSIONS (HxWxD) (mm)	1.980 x 1.450 x 810
	INTERNAL DIMENSIONS (HxWxD) (mm)	1.330 x 1.320 x 680

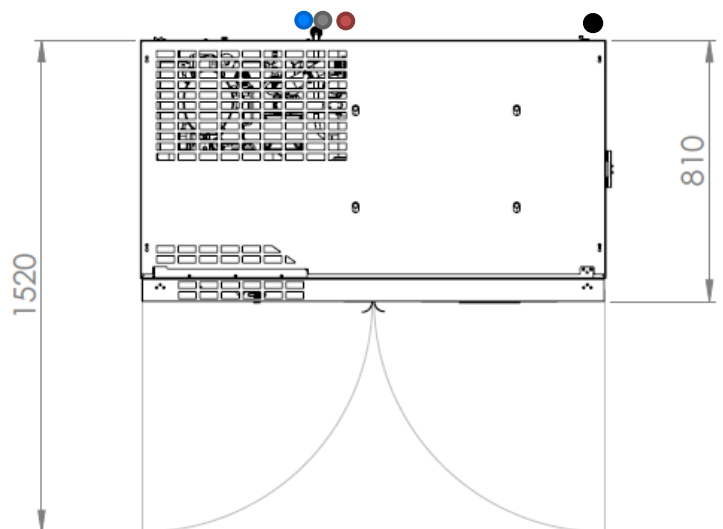
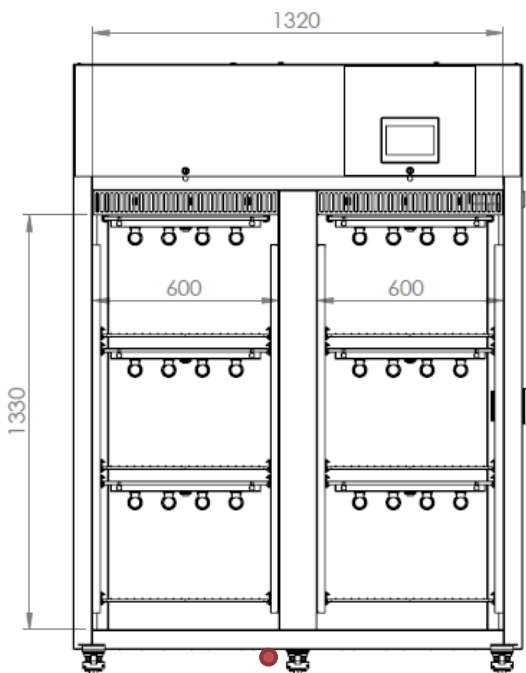
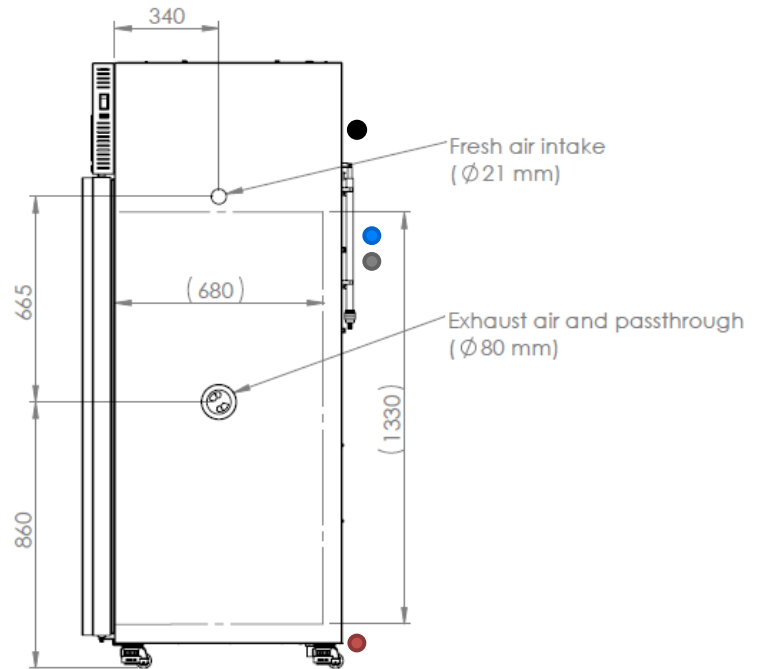
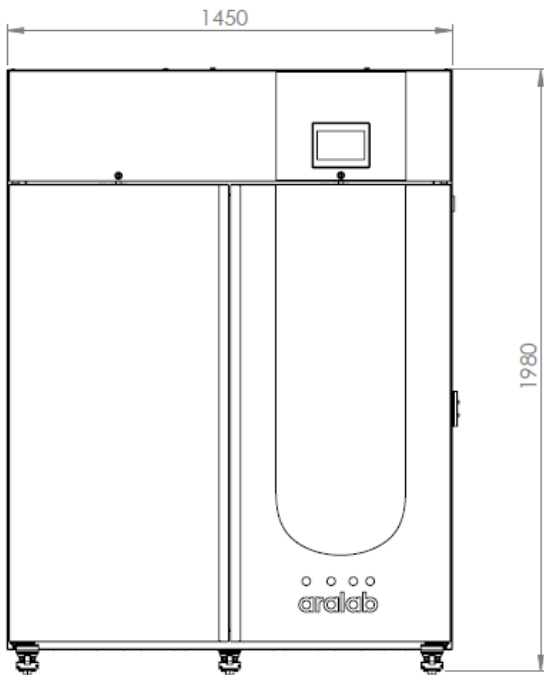

- Standard refrigeration system is air cooled
- Services hub installation needs:
 - Services hub installation needs:
 - 1/2" demineralized water supply
 - 50mm water drain at floor level
- Electrical cabinet installation needs:
 - Supply power: 230VAC, 50Hz, 16A / Single Phase + Neutral + Ground
 - Electrical protection: Circuit breaker 16A + N with 300mA differential
 - RJ45 communication port

EQUIPMENT DESCRIPTION

CONSTRUCTION & CONTROL

- Multi-color 7-inch touch-screen ClimaPlus© controller
- Open door alarm with configurable time-out function
- Free slots for connecting and integrating external devices (CO2 control, Automatic Irrigation/Aeration, Shakers or other) with the ClimaPlus controller
- Accessible technical compartment for faster maintenance procedures
- Highly resistant stainless-steel interior
- Polyurethane insulation
- Exterior zinc plated steel and gray epoxy paint
- Pivoting door(s) with spring lock, magnetic gasket and safety lock(s)
- 4 and 5 built-in casters brakes for effortless mobility and installation
- 80mm Ø side entry port

ENVIRONMENTAL CONTROL

- Air-cooled, CFC free, mechanical refrigeration by hermetic compressor
- Dual heating technology with hot gas by-pass and stainless steel electric heaters
- Humidification by ultrasonic generator with automatic water level control and self-cleaning function
- Dehumidification by condensation on the cooling system evaporator
- PT100 RTD temperature sensor and capacitive humidity sensor

AIR FLOW

- Dynamic airflow with EC (variable) blower
- Air renovation through adjustable lateral port-holes
- Uniform air velocity of 0.2 meters per second across shelves
- Airflow speed adjustable on the ClimaPlus© controller

RESEARCH PROTECTION AND AUTOMATIC DIAGNOSTICS

- Independent thermostats for maximum and minimum temperature limits
- Automatic cut-off function, in case of excessive heating or cooling
- Configurable maximum and minimum temperature and humidity limits
- Visual and audible alarms for temperature and humidity limits
- New synoptic diagram function: a self-diagnostics tool that checks all active components of the system allowing for faster procedures and minimizing any possible downtimes

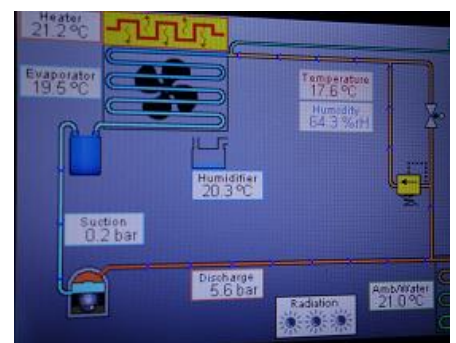
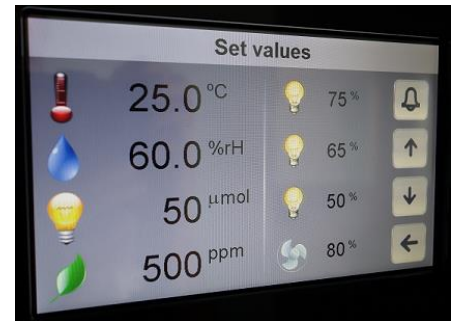

CLIMAPLUS CONTROLLER

- Programmable Logic Controller exclusively developed by Aralab for FitoClima chambers
- Easy to use touch-screen interface
- 190mm x 150mm multicolor display
- Controls every environmental variable available for any specific FitoClima model (Temperature, Humidity, Lights, Airflow, CO2 and connected external devices)
- Friendly program editor for creating 32 programs of 24 segments each, allowing the design of complex and comprehensive climatic simulation programs
- Password protection of the controller functions
- Content and research protection feature, with configurable High and Low Temperature and Humidity alarms and automatic notifications
- Managing, monitoring and recording of all alarms
- Non-volatile memory, allowing the automatic restart of previously defined set-points or on-going programs due to power failure, without losing data
- Real-time monitoring of all the functions and active components of the equipment, allowing for a fast and accurate diagnostic in case of malfunction
- Possibility to control and program events by external commands and with external devices
- Graphical view of programs and climatic variables
- Ethernet port for connecting logging computer to the chamber controller
- ClimaPlus controller functions also available at the PC/Laptop with the FitoLog software pack

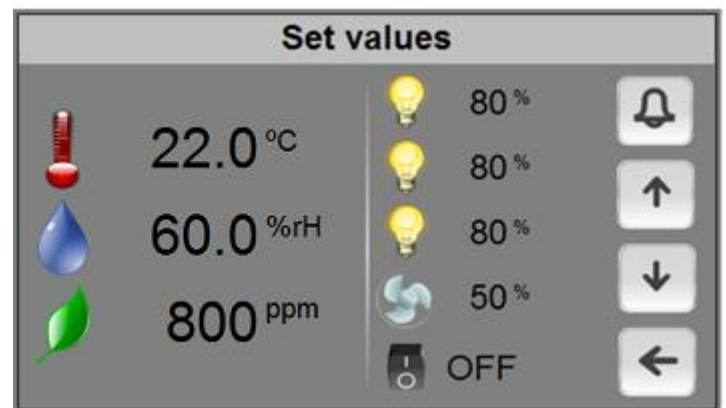

FITOLOG SOFTWARE

The FitoLog software pack is a set of applications designed to facilitate the managing, monitoring and recording of programs and data from the FitoClima chambers. It consists of 3 applications: **FitoLog**, **FitoLogView** and **FitoProgram**.

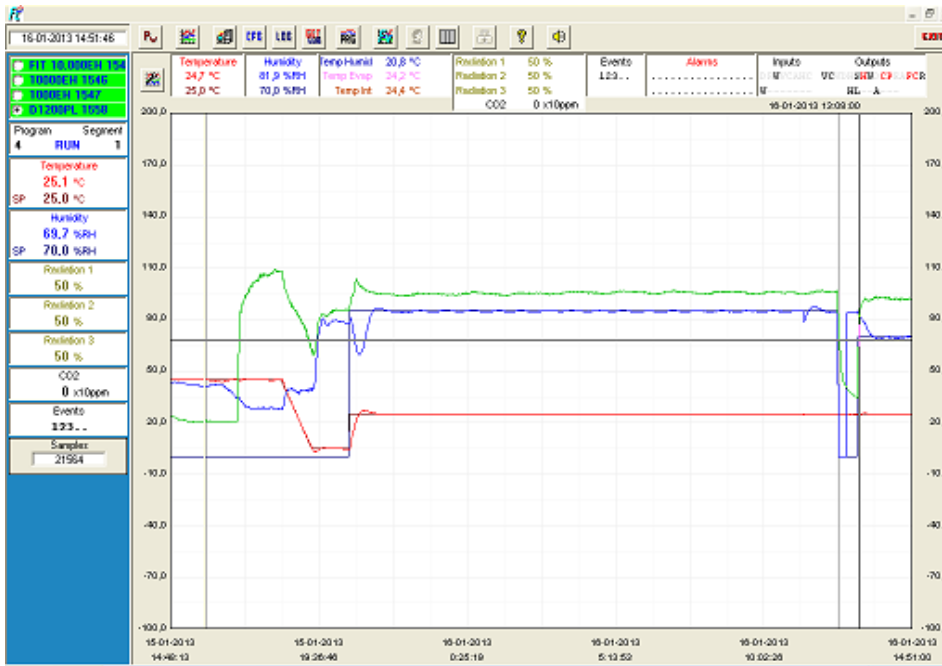

FitoLog: Records and displays in real time all data and details related to the set-points, running variables and equipment behaviour. It also retrieves information about the active components of the chamber, running processes, errors, alarms and allows the configuration of periodic or alarm triggered remote notifications (by email or SMS, depending on existing connections and accessories).

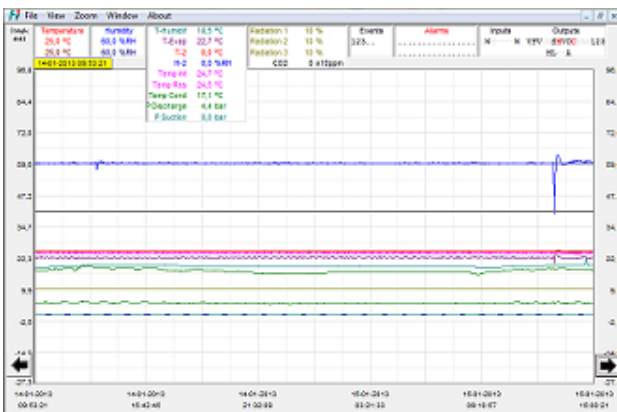

FitoLogView: It is a working tool to process the data recorded by the FitoLog program. One can view, print and export the log contents to other file types, and analyse the data in other data management software (Excel, Star Office, Access or others).

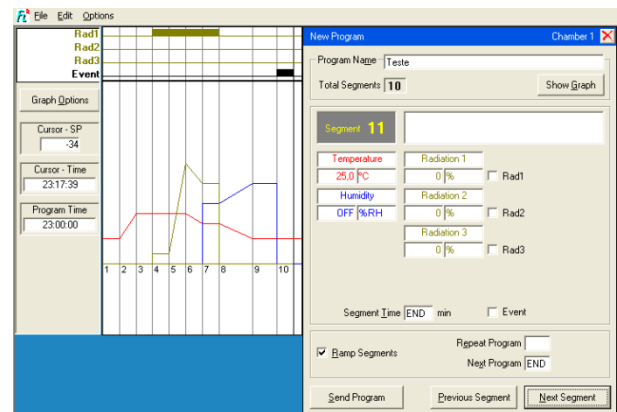

FitoProgram: This application simplifies the creation of programs and its integration on the chamber ClimaPlus controller. Up to 32 programs, each with 24 segments, can be designed and linked to create detailed environmental profiles and simulations.

Research secured with alarms, notifications, fast diagnostics and prompt troubleshooting: With **FitoLog** it is possible to gather data from each of the chambers systems, which makes it a very useful tool to diagnose any necessary maintenance. This tool works as the “black box” of the equipment, giving Aralab technicians the necessary data to remotely carry out a fast and efficient diagnostic. All that is needed is a FitoLog file.

COMMON ACCESSORIES (PLEASE CONSULT ARALAB FOR OTHER ITEMS)

- FitoLog® software pack for PC/Laptops, enabling data monitoring, logging and managing operations directly on a computer
- Quantum light meter integrated with the controller for managing light intensities in $\mu\text{moles}/\text{m}^2\text{s}$
- CO2 monitor and controlling units
- CO2 scrubber for lowering carbon dioxide below ambient levels
- Dew and Mist simulation
- Automatic irrigation valve
- Aeration kit for Algae Research and Hydroponic cultures
- External 20 litre water tank with electric pump and security valve
- Double glazed glass doors with or without cover lid
- Phenolic resins coating for Entomology/Insects rearing applications
- High performance lighting kit (+1.000 $\mu\text{moles}/\text{m}^2\text{s}$) with heat extraction system
- LED modules with fixed spectral distribution
- LED modules with configurable spectral distribution

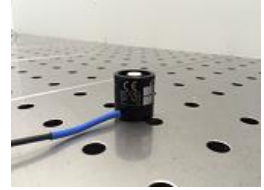

High Performance fluorescent with heat extraction system



Heliospectra LED modules configurable spectral distribution

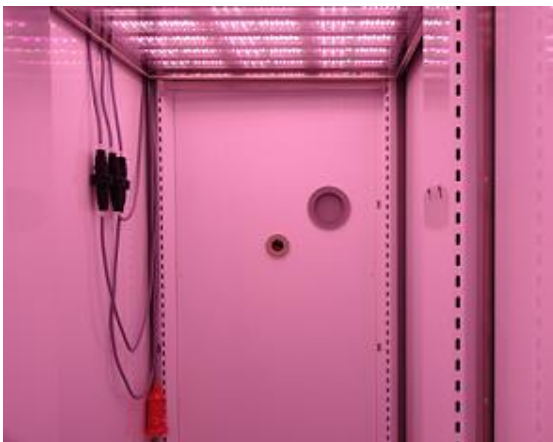

High performance LEDs with heat extraction system



Vertical LED lights

Features and specifications are subject to change. Aralab continuously studies ways to further develop its products to achieve better performances and overall product quality. As a result, characteristics and specifications provided in this document may be subject to changes.

YOUR OWN CLIMATE
Our main goal

Let's meet!
aralab@aralab.pt
www.aralab.pt
T: +351 219 154 960